

Back Spine Assembly

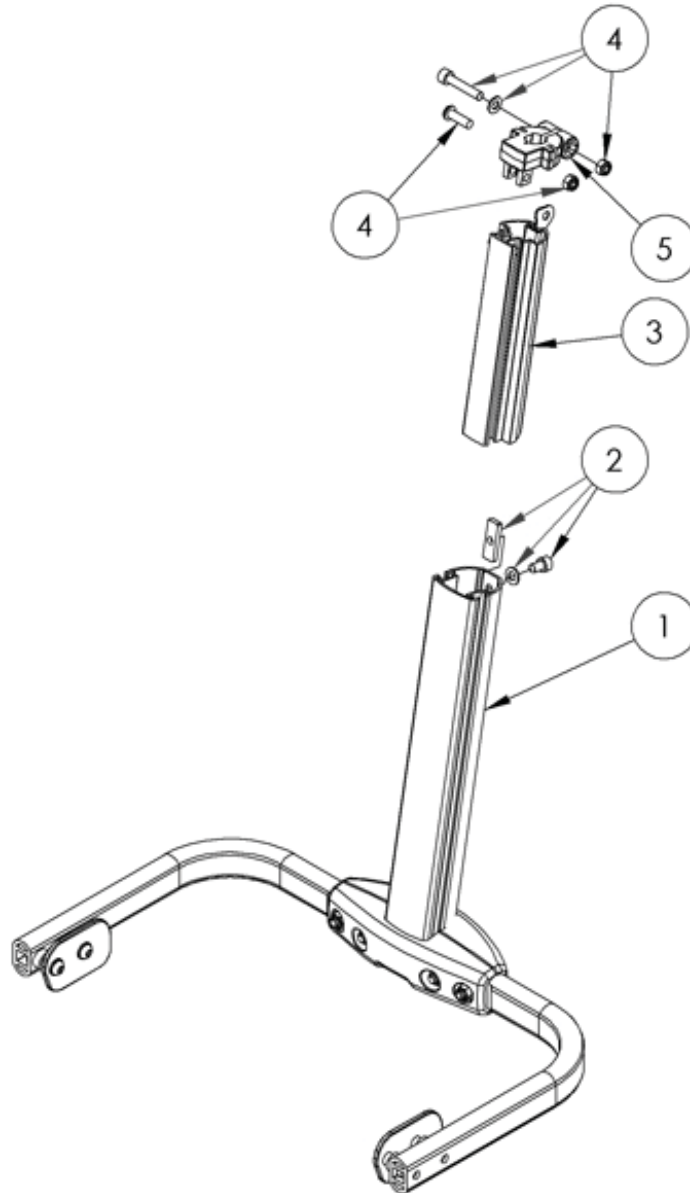

Pos.	Leckey Code	Description	Qty	Compatible with	
				Size 1	Size 2
1	133-2022	Backspine Assy	1	✓	✓
2	133-2017	Spine Clamp Adjustment Kit	1	✓	✓
3	133-2026	Spine Upper S1	1	✓	
3	133-2027	Spine Upper S2	1		✓
4	133-2028	Head Support Clamp Bolt Kit	1	✓	✓
5	133-020	Head Support Clamp	1	✓	✓