

Hi-Low Chassis

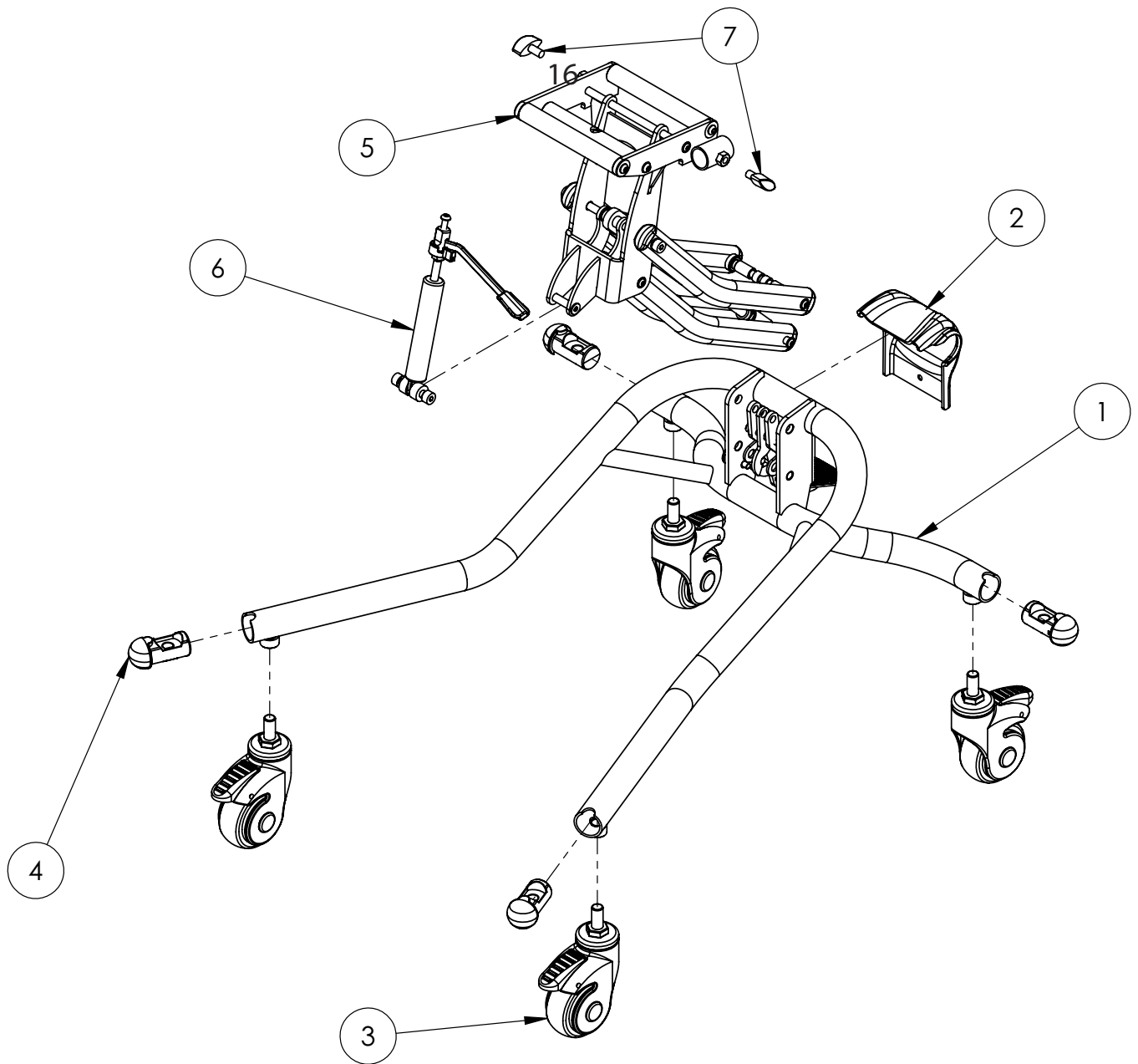

Pos.	Leckey Code	Description	Qty
1	120-800	Squiggles Chassis Assembly	1
2	120-371	Chassis Rear Moulding	1
3	IA32	Castor	4
4	118-160	Castor Tube Insert	4
5	120-802	Chassis Arm Assembly	1
6	120-812	Bansback Tilt Spring Assembly	1
7	SF19	Locking Key (M8 X 16)	2